



METAL PLAY PRODUCTS

Durable and fun

Contents

Mix & Match!	4
MyDesign-theme play	6
Swings	8
Spring and carousel products	11
Balancing	16
Climbing frames	17
Multiactivity equipment	21
Sandboxes	23
Play houses	23
Park signs	23
Multi activity equipments	23
Wall-holla	24
Warranty	31

Create surprise and joy

To summarise the Lappset's entire history, we have always wanted to build comfortable surroundings and provide users with an enjoyable playing and exercise experience that also develops their skills, almost without them noticing.

For this reason, catering for various age groups and their needs is an essential part of our product design. User-oriented thinking also ensures the safety of our products. Our clients have a unique access to tailored products and personal design. This process constantly creates new, innovative sets which are clearly distinguishable from the ordinary.

Our materials and designs can easily be combined into versatile park ensembles – a feature that we have taken into account at the design stage. You can even mix products from different series without compromising usability and style.

Lappset offers metal products for various age groups and purposes. A well-designed park is a place where children, teenagers and adults enjoy playing and exercising together.

Welcome to Lappset's world of play!

Durable metal play equipment

- Robust materials with 20 years of warranty
- Low maintenance
- Vandalism resistant
- Safety tested and TÜV-certified
- Recyclable

Lappset's robust metal products are designed to withstand even rough play. Intended for parks and playgrounds, this low-maintenance equipment is resistant to vandalism and provides years of safe and developmental exercise and fun.

The products are made of steel or aluminium with durable high-pressure laminate (HPL) walls. All of these materials endure even harsh climate conditions. Lappset metal products are also fully recyclable.





Ask your local dealer for Lappset Sport & Parkour solutions!

Mix & Match!

Lappset playgrounds and exercise facilities encourage all generations to engage in an active lifestyle. Design your own ensemble with Lappset's durable metal products!

Form follows function, and functional equipment provides a setting for incomparable experiences. All of Lappset's metal products are compatible in terms of design and material – combine them freely in the same yard or playground.

Our design service will gladly assist you in choosing the most suitable products for your target group from the wide selection presented in our brochure. Our experts will help you take account of the needs of different generations, in order to create a solution that delights as many users as possible.





MyDesign!

When you want to create unique products or need help in designing a playground area, turn to Lappset's MyDesign! service. Our MyDesign! designers will help you to customise standard products or create unique themed products..

You can also consult our design service if you need advice in designing a park, exercise facilities or the

yard of a housing company. Contact us to benefit from our designers' experience!

You will find support and inspiration for your designs from the selection of products already customised by the MyDesign! service, at <http://mydesign.lappset.com>. The gallery contains hundreds of products and sets which you can use to help realise your plans.

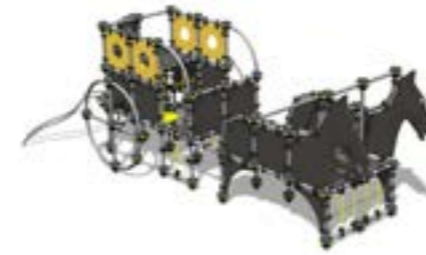

Q60035
HORSE CARRIAGE



Q03459
FIRE TRUCK

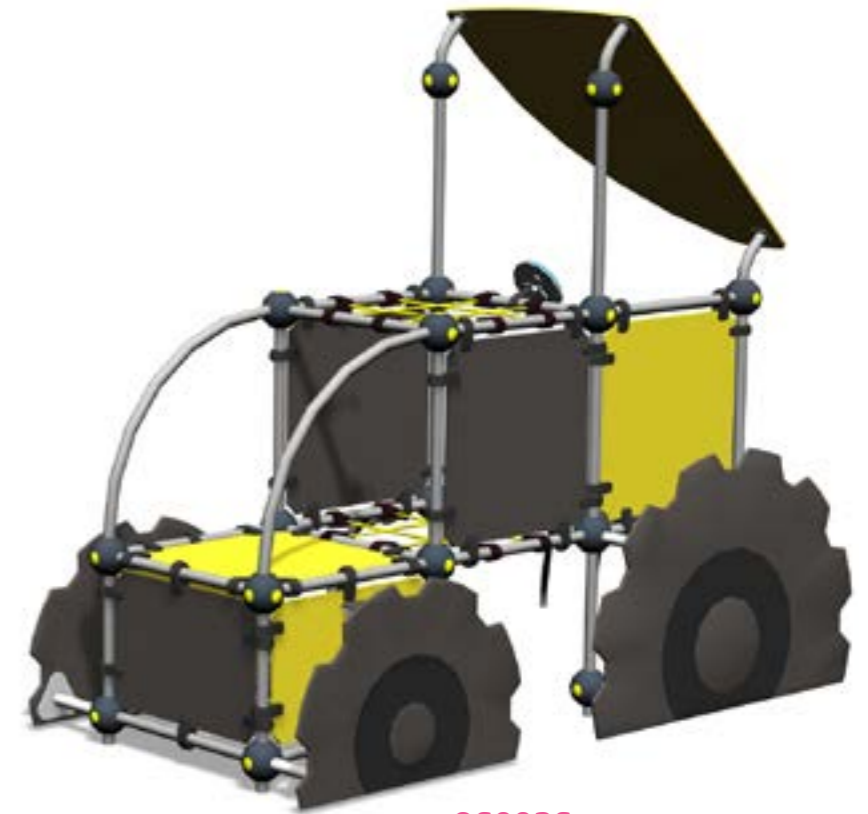

Q60036
TRACTOR

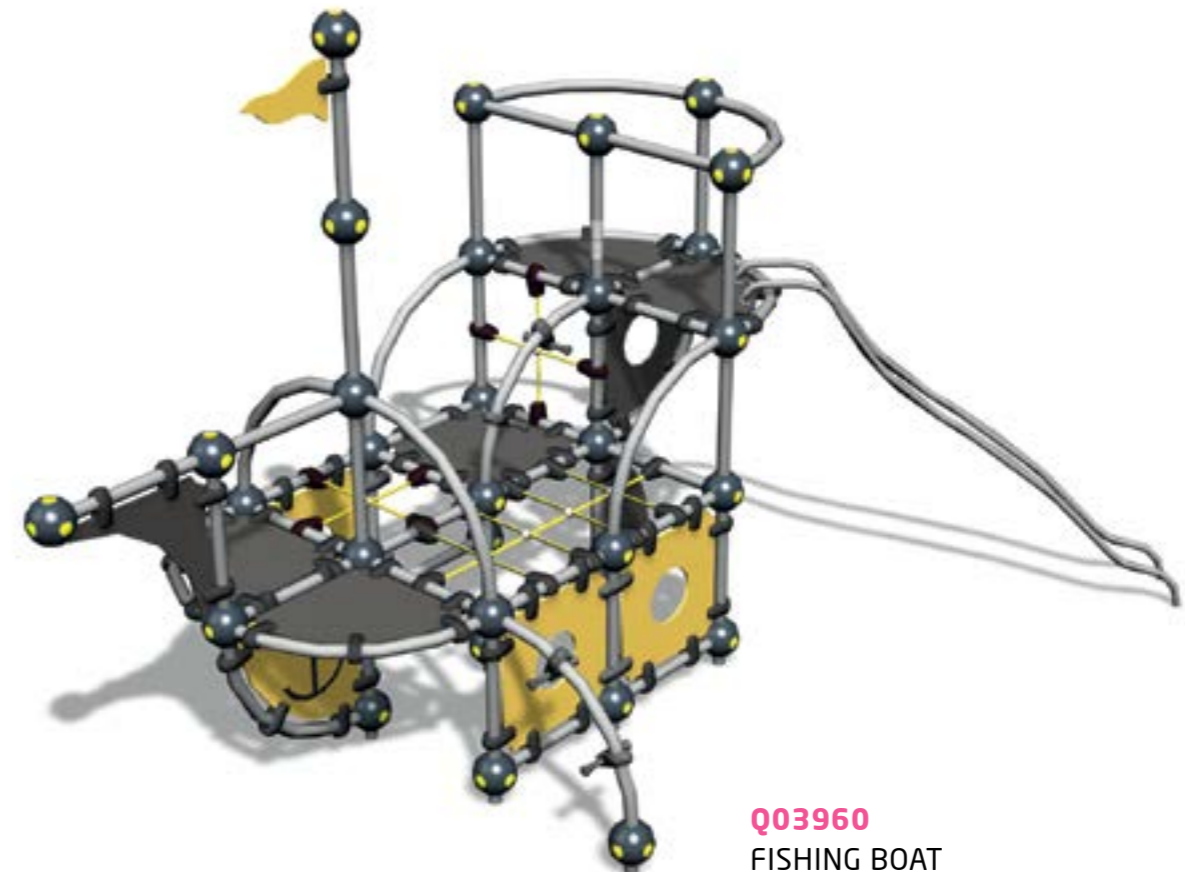

Q03960
FISHING BOAT



Metal swings

Swinging never ceases to appeal to children of all ages. Children, in particular, gladly spend a lot of time on a swing. Research also suggests that swinging and rocking motions have several benefits. Swinging stimulates the vestibular system located in the inner ear, which in turn develops motor coordination and balance. The swinging

motion also soothes the mind. According to a recent study, rocking even induces deeper sleep. In children's occupational therapy, swinging is used as a means of activation. By changing the colors and types of foundations you will certainly receive the most convenient solution for your destination.

Colour options for metal swing frames:

- RAL7024
- RAL9023
- Hot-dip galvanised
- = chain 160 cm
- = chain 210 cm



220005M
TANTALUM
Includes seats.



220001M
TERBIUM *



220061M
THULIUM **



220002M
TELLURIUM *



220063M
KEINUTELINE **



220062M
THORIUM **



220064M
SWING FRAME FOR 3 **



220069M
SWING FRAME FOR 4 **



220066M
THALLIUM **
Includes bird's nest seat.

220067M SWING FRAME+
BIRD'S NEST SWING **
Includes bird's nest seat.



220070M
SWING FRAME FOR 6 **



220068M SWING FRAME FOR
2+ BIRD'S NEST SWING **
Includes bird's nest seat.

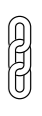

* Available with rubber seat or cradle seat. Seats must be ordered separately. Underground foundation without concreting can be carried out by using foundation assembly. Foundation assembly elements must be ordered separately.

** End plates available also in yellow. Underground foundation without concreting can be carried out by using foundation plates. Plates must be ordered separately.



000218 000228
CRADLE SEAT



000216 000226
RUBBER SEAT



000217 000227
TYRE SEAT



000104
HUGO & INES
Swing seat for the whole family!



SWING CHAINS

The chains of all our swings are made of Ø 6 mm stainless steel, which guarantees the best protection against corrosion even in the harshest conditions.

= chain 160 cm
 = chain 210 cm



FOUNDATION PLATES FOR SWINGS

Swing frame foundation plates do not require concreting.

Foundation assembly elements should be used with 220001M, 220002M and 220005M. Foundation plates for all other swings.



Foundation plates



Spring and carousel products

Spring and carousel products open up an opportunity to enjoy the strength of one's body. The products are easy to push into speed and movement, propelled by the user's own body. Spinning around, swaying from side to side, and wild rides all bring the joy of an amusement park to everyday life. The movement of the spring and carousel products also trains rhythmic awareness and tests the sense of balance.

When installing spring and carousel products, the designer must remember to observe safety zone instructions. As spring and carousel products involve momentum, their safety zones must not overlap with the safety zones of adjacent products.



220034
FROGGY



137003M
IODINE



137043M
XROLL



220041
XSPEED FOR 2

137042M



200020
SPINNING MACHINE **



220032M Ø350
RAL7024 ■ RAL3020 ■
COPPER



137004M
RUMBA



010501
HORSE *



010504
MOTORCYCLE *



010507
RHINO *



010512
MOOSE *



010502
DOG *



010505
WHALE *



010508
GIRAFFE *



010514
FISH *

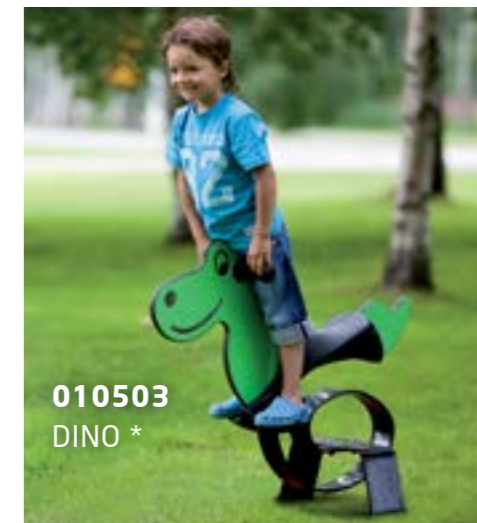

010503
DINO *



010506
MOUSE *



010511
SEAHORSE *



005049 **706923**
DEEP MOUNT. SURFACE MOUNT.

* Deep mounting.
** Surface mounting.

* Deep mounting foundation 005049 or rubber base 700846B for surface mounting must be ordered separately.



010710
FOX *



010515
TRACTOR**



J51511M
PICO **
RAL7024 ■
RAL3020 ■
RAL1003 ●



220050
SEESAW FOR 2



220012M
CARBON **



220013M
RHODIUM **

RAL7024 ■
RAL3020 ■

RAL7024 ■
RAL3020 ■



Q04631
DUCK *



Q03788
CAMEL*



Q03460
SHARK*



096319
CABBAGE WORM



096320
LADYBIRD FOR 2



096321
LADYBIRD FOR 4

* Deep mounting foundation 005049 or rubber base 700846B for surface mounting must be ordered separately.
** Includes foundation.



096322
LADYBIRD FOR 8



705101
DEEP MOUNT.



705998



705101
SURFACE MOUNT.

* Deep mounting foundation 005049 or rubber base 700846B for surface mounting must be ordered separately.
** Includes foundation.



Balancing

Although the sense of balance develops before birth, we continue fine-tuning it throughout our lives. Balance protects the body from injuries by preventing accidents. The most intense development phase of balance takes place between the ages of 5 and 7, but its maintenance and development need constant training.

Balance is maintained by many parts of the nervous system and muscles. Even light balance training strengthens the cooperation between the sense of sight and the sense of touch in the soles of the feet. This is developed further through repetition. Balancing also improves body control, which helps individuals to perceive themselves in relation to the surrounding space.

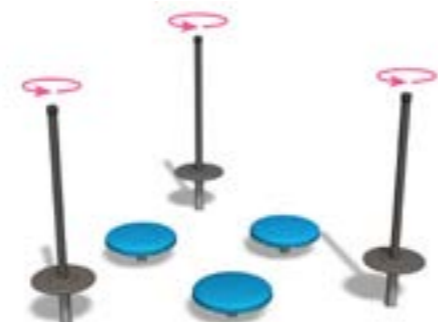
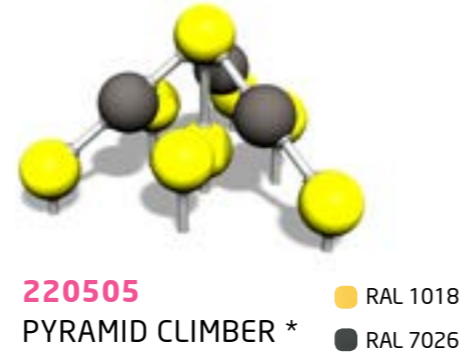

137200M
ROCKER

200010
SURFY

220037
UNION



Q02613
BARIUM

220541
PRECISION BEAM

220542
PRECISION BEAM WIDE

* Deep mounting foundation 160000 must be ordered separately.

Climbing

Children's ability to cross the body's midline is a prerequisite for them to learn to read and write. For this reason, climbing is a most effective exercise, for example as a way of taking a break in the middle of the school day. In climbing ladders and networks children make use of all four limbs, which helps them achieve better physical awareness. At the same time they learn to control and coordinate both right and left side.

Climbing also interests older children, being a natural opportunity for learning to avoid danger. When children face their fear and test their skill on a climbing frame, they become more ready to face the unexpected.

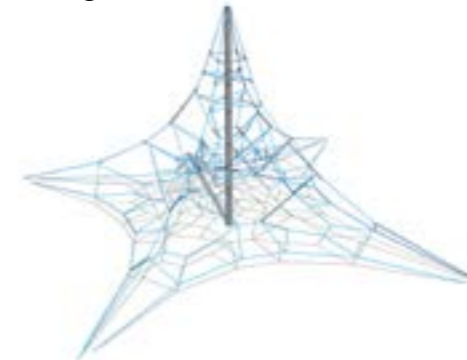

200203 Blue/Gray
220203 Yellow/Black
PYRAMID NET L*

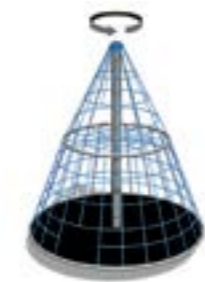
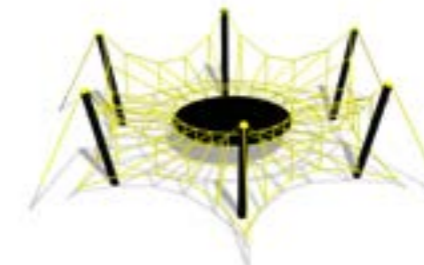
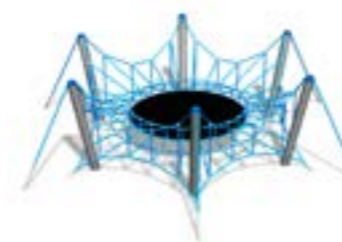

* Deep mounting.



220090M
PLATINIUM



220130
OXYGEN



220131
OXYGEN MINI



Q02371
OXYGEN PLUS



220080M
CADMIUM



220470
CLIMBING RACK



220460
NEPTUNIUM



220464
NIOBIUM



220466
STRONTIUM



220468
URANIUM



Q03610
CHINNING BARS FOR 3

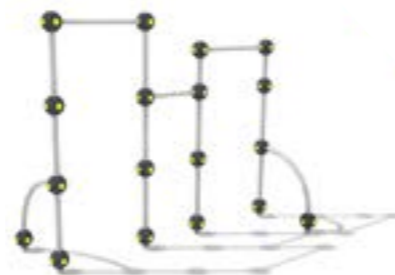

Q03878
CHINNING BARS FOR 3



220620
WALL BOULDERING CUBE XL

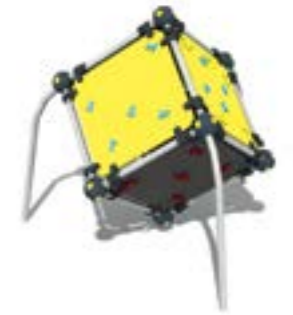

220605
WALL BOULDERING CUBE S



220610
WALL BOULDERING CUBE M



220615
WALL BOULDERING CUBE L



220680
WALL BOULDERING S

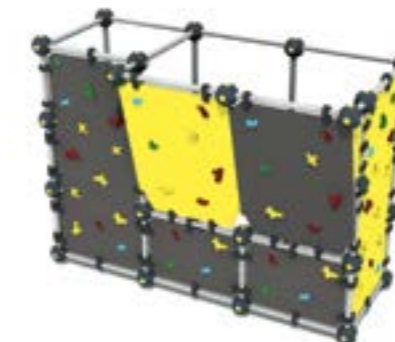

220685
WALL BOULDERING M



220690
WALL BOULDERING L

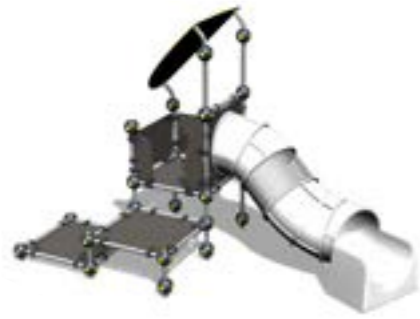

Q02529
KRYPTON III



Q02467
CLOXX TORNI

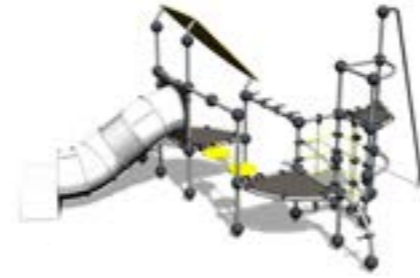

Q02468
RADON



Q03537
RADON



Q03843
CLOXX TOWER



Q03785
XENON

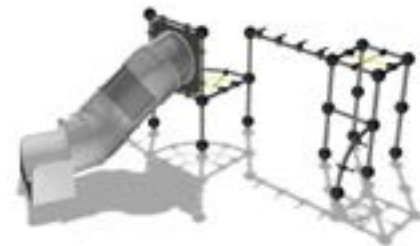

Q03874
CLIMBER



Q03445
CLOXX TOWER



Q40332
CLOXX TOWER

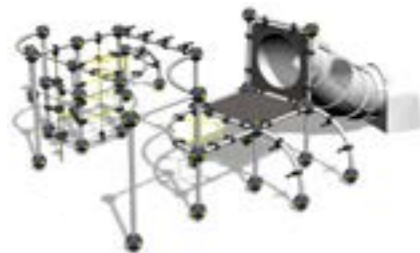

Q03887
CLOXX TOWER



Q03889
CLOXX TOWER



Q03954
CLOXX TOWER



Multiactivity playequipment

The majority of Lappset's multi-activity centres can be equipped with a slide which best suits your needs. There are three materials and shapes. When selecting a slide for your product, think about the main user group. Which slide should you have in your playground to set the imagination soaring and spark delight from one day to the next?

The surrounding conditions should be kept in mind when choosing the slide material. In warmer climates, under

direct sunlight, plastic slides will not get too hot for sliding. If the park equipment is for rougher than average use, high pressure laminate is recommended instead of wood or plastic.

The Tube is a unique product in Lappset's product range. Because the Tube is assembled out of modules, it can be made into nearly any shape. It can also include transparent parts. Thanks to its modular structure, the Tube also rises higher than other slides.



220306
RENIUM



220338
PLAY TOWER



220336
PLUTONIUM



220304
ARGON



220300
NICKEL



220305
NITROGEN



220340
PLAY TOWER



220328
BARIUM



220308
CALCIUM

Sandbox

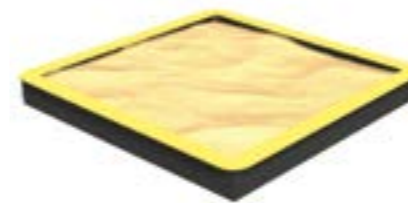

Q02530
SANDBOX *



Q03858
SANDBOX *

Play house

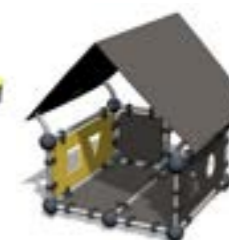

Q02459
PLAY FUN



Q02460
PLAY FUN

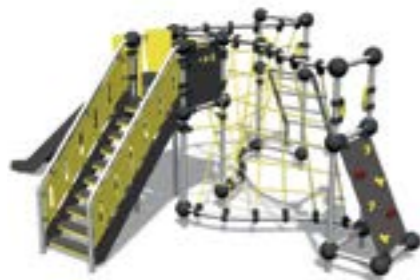

220332
IRIDIUM

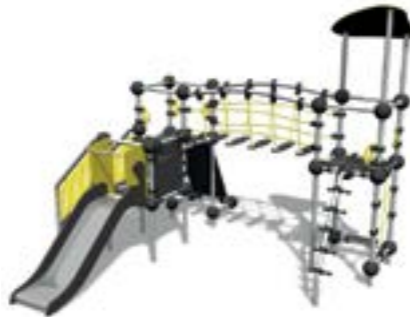

220325
KRYPTON



220310
RADIUM



220110
NEON



Q02347
NEON



220140
COBALT



220316
RADON



220313
VANADIUM



220320
XENON



220120
LITHIUM



220150
TITANIUM

Signs



J14712
PARK SIGN *



220590
PARK SIGN

* Deep mounting.

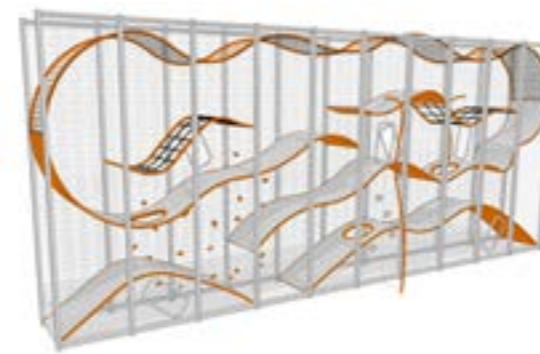

400110
WALL-HOLLA 10



400110ES
WALL-HOLLA 10 WITH END SLIDE



400110IS
WALL-HOLLA 10 WITH SIDE SLIDE



400110G
WALL-HOLLA 10 WITH GOAL

Wall-holla / An exciting play centre with several floors

Adventure-inspiring Wall-holla products are available only from Lappset. These products are available in several sizes, the largest being almost 21 metres long. Contact your local dealer for availability and specific product dimensions.

	CLIMBING ROUTES	FIREMAN'S POLE	END SLIDE	SIDE SLIDE	INTEGRATED GOAL
400107	3	1	400107ES	400107IS	400107G
400109	3	1	-	-	400109G*
400110	4	2	400110ES	400110IS	400110G
400111	4	1	-	-	400111G*
400113	4	2	-	-	400113G*
400114	6	2	400114ES	400114IS	400114G

* goal centered

Ask your local dealer for colour options.

Warranty for metal products

20 years

- steel components and structures
- elements made of high pressure laminate (HPL)

15 years

- aluminium components
- glass fibre reinforced plastic components

10 years

- surface finish of steel and aluminium components

5 years

- plastic and fibreglass parts
- steel reinforced nets and ropes
- springs

3 years

- rubber and rubber-coated parts, polyurethane parts
- moving parts malfunction
- steel cables, chains

The warranty covers structural strength, materials and manufacturing faults. The warranty does not cover faults resulting from negligent installation and maintenance, normal wear and tear, and slight fading of colours. Warranties do not cover damages caused or incurred by misuse, vandalism or natural disasters.

See detailed warranty terms from our website:
<http://www.lappset.com/Services/For-designers/Warranty>





 **LAPPSET®**

LAPPSET GROUP LTD
P.O. BOX 8146
FIN - 96101 ROVANIEMI
Tel. +358 207 750 100

lappset@lappset.com
www.lappset.com

@LappsetGroup